

Status: 02/2021

cab
we identify more



Products need labeling
Labeling heads

IXOR
Made in Germany

Smallest servo-driven labeling head in its performance class

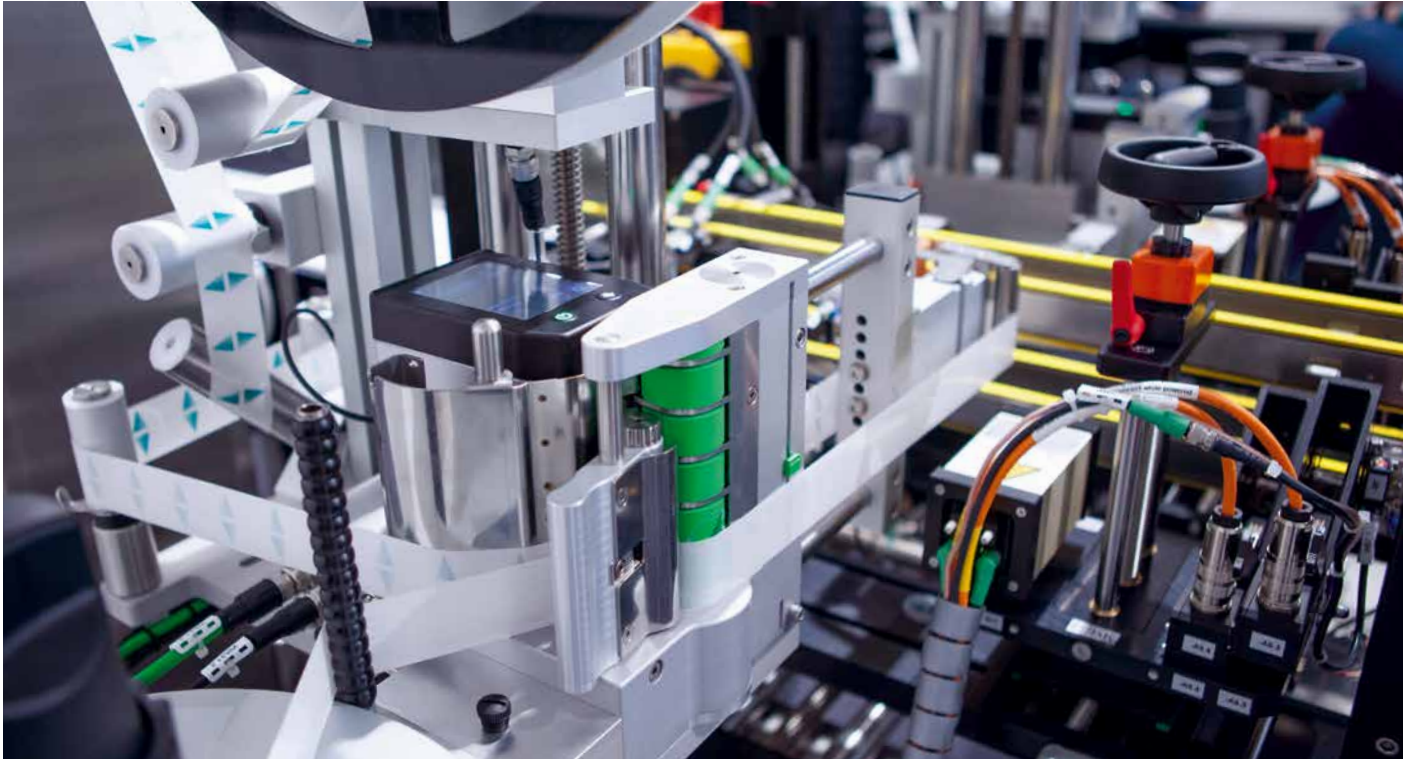

A future-proof investment

In the matter of mechanics, the IXOR can be ideally integrated in fully automatic labeling machines with the help of a modular construction kit. It can also be assembled to the conveyor belt of a production line by means of accessorial stands. Pre-printed labels are applied on products or packaging fast and precisely.

The device has the control unit integrated, a separate control cabinet is not required. The base unit can be selected from four structural widths in right-hand and left-hand designs. Unwinders pick up label rolls with 410 mm maximum outside diameter.

Zero downtime is possible through a redundant system.

The labeling head is a key component for smart production. The LAN and WLAN interfaces enable the device to be connected to the superior control units of machines.

MQTT, Modbus and OPC UA ensure cross-platform and future-proof communication. Protocols are kept simple and lean, machine and plant data can be submitted event-driven. If data values change, updates are possible in real time.

Remote IXOR operation with a smartphone, a tablet or a PC is possible at any time. The intuitive web interface allows backup, restore and updates.



Scopes of delivery, design and technical specifications correspond to the date of the printing. Subject to change. The data provided in the catalog do not represent any warranty or guarantee.



Information is also available on the Internet:
www.cab.de/en/ixor



Examples of construction

**Construction L - left-hand
Assembly V - vertical**



Pictured:

- 1.1 Labeling head 124 L
- 2.1 Unwinder D310 V 124 L
Outside diameter D: 310 mm

**Construction R - right-hand
Assembly V - vertical**



Pictured:

- 1.1 Labeling head 124 R
- 2.2 Unwinder D410 V 124 R
Outside diameter D: 410 mm

**Construction R - right-hand
Assembly V - vertical**



Pictured:

- 1.1 Labeling head 124 R
- 2.1 Unwinder D410 V 124 R motor-driven
Outside diameter D: 410 mm

**Construction L - left-hand
Assembly H - horizontal**



Pictured:

- 1.2 Labeling head 186 L
- 2.2 Unwinder D410 H 186 L
Outside diameter D: 410 mm



For more examples of construction
see delivery program starting on page 19.

Operation panel



Home screen

1 Status bar

Speed, label winding, current label roll diameter, label length, WLAN signal, status of start and stop signal

2 Operational and warning messages

in alternation with the cab logo

3 Counter and diagnostics indication

Application-specific configuration

4 Quick menu for comfortable editing of values

Quick adjustment with a slider, precise adjustment with the help of a button

Speed
91.6 m/min

Press briefly
Labeling speed adjustment

Press for 3 or more sec.
Masterencoder test

Start delay
208.5 mm

Press briefly
Change the label position on the product

Press for 3 or more sec.
Start sensor compensation wizard

Stop delay
63.2 mm

Press briefly
Adjustment of label stop on the peel-off plate

Press for 3 or more sec.
Label sensor
AutoTeach feature

Menu selection

Press briefly
Jump to menu via icons

Press for 3 or more sec.
Password login

Speed

40.0 m/min

1.0 100.0

[-] [+] [✓]

Start delay

330.0 mm

11.6 1000.0

[-] [+] [✓]

Stop delay

40.6 mm

10.0 500.0

[-] [+] [✓]

Menu

Speed Start Stop

Print Apply System

Format Test Service

Software features

Menu icons one by one



Label speed

including synchronized product speed



System settings

Display, language
Metric / inch units
Pre-warning to end of label web



Label position on the product

including multi-labeling;
start condition



Application-specific configuration

a maximum of 100 formats;
backup and restore with the help of a PC



Label stop on the peel-off plate

including detection of labels missing on the liner tape;
stopp condition



Simulation and testing

Display and setting of inputs and outputs
for service purposes



Print settings

for the control of optional printers;
printing while labels are in motion or not in motion



Service tools

Maintenance wizard
Lot counter
Video tutorials



Transfer settings

for the control of optional label transfer units
such as applicators, air-jet box, etc.

Sub menu and service features



Sub menu

with more than 150 features

I/O-Test	
Inputs	Outputs
<input type="checkbox"/> FEED Manual label feed	<input type="checkbox"/> BTN_FEED Button FEED press
<input checked="" type="checkbox"/> START Start labeling	<input type="checkbox"/> FEEDING Label feeding
<input type="checkbox"/> LOCK START is locked	<input type="checkbox"/> PRT Start print
<input type="checkbox"/> STOP Stop label feeding	<input checked="" type="checkbox"/> READY Ready to start
<input type="checkbox"/> DIM_IN Diminish. label reel	<input type="checkbox"/> DIM Diminishing label re
<input type="checkbox"/> END_IN End of label reel	<input type="checkbox"/> END End of label reel
<input checked="" type="checkbox"/> ON ON/OFF by input	<input type="checkbox"/> NO_LABEL Missing label
<input checked="" type="checkbox"/> RESET Reset error	<input type="checkbox"/> ERROR Stopped by error

I/O test

Status display of all inputs and outputs;
ideal with initial operation, especially
when the labeling head integrates
in external control units

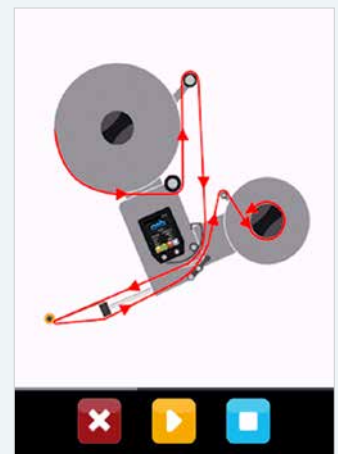

Video tutorials

Watch feed path schemes on the
display. Scan QR code with a mobile
device to see more explanatory clips.

Details - standard labeling head

The subsequent illustration shows a very common IXOR version.

This configuration is characterized by an economic and compact construction.

The unwinder and the rewinder are mounted directly on the base unit and operate without a separate drive.

In contrast, the illustration on the right shows an IXOR with a motor-driven unwinder and a motor-driven rewinder, enabling to process large label rolls.

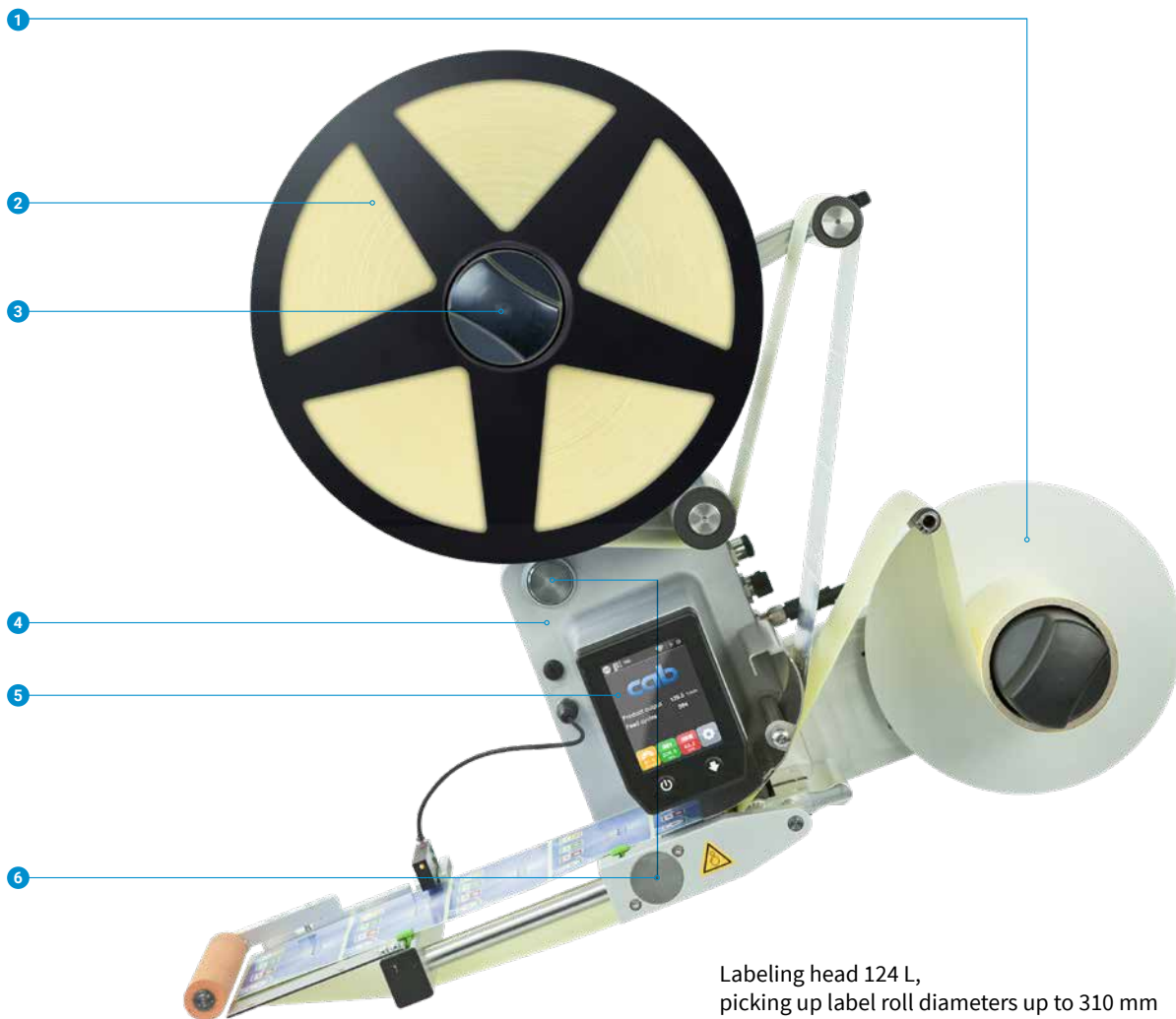

Labeling head 124 L,
picking up label roll diameters up to 310 mm

1 Rewinder

When the labels have been peeled off, the liner tape is rewound. The swing lever and an integrated coupling enable the liner tape to be constantly tensed after passing the drive roller.

2 Unwinder

picking up label rolls with 310 mm (optionally 410 mm) maximum outside diameter. The swing lever and an integrated brake mechanism enable constant tension of the label web.

3 (Label roll) core retainer

By turning the handle, the core of the label roll is tightened and released again.

4 Base unit

made of cast aluminum. Basis to assemble all the units. The chassis possesses protection class IP66, NEMA 250 type 12. Further included is the drive unit consisting of a highly dynamic and high-torque servo motor.

5 Operation panel

Colored 3.5" LCD touch display. In case of overhead assembly, the display can be rotated by 180°.

6 Pick-up points

on bars with 30 mm diameter. By moving the system, the position of the label on the product can be adjusted transverse to its transport direction.

Details - labeling head with motor-driven winders

Labeling head 124 L,
picking up label roll diameters up to 410 mm

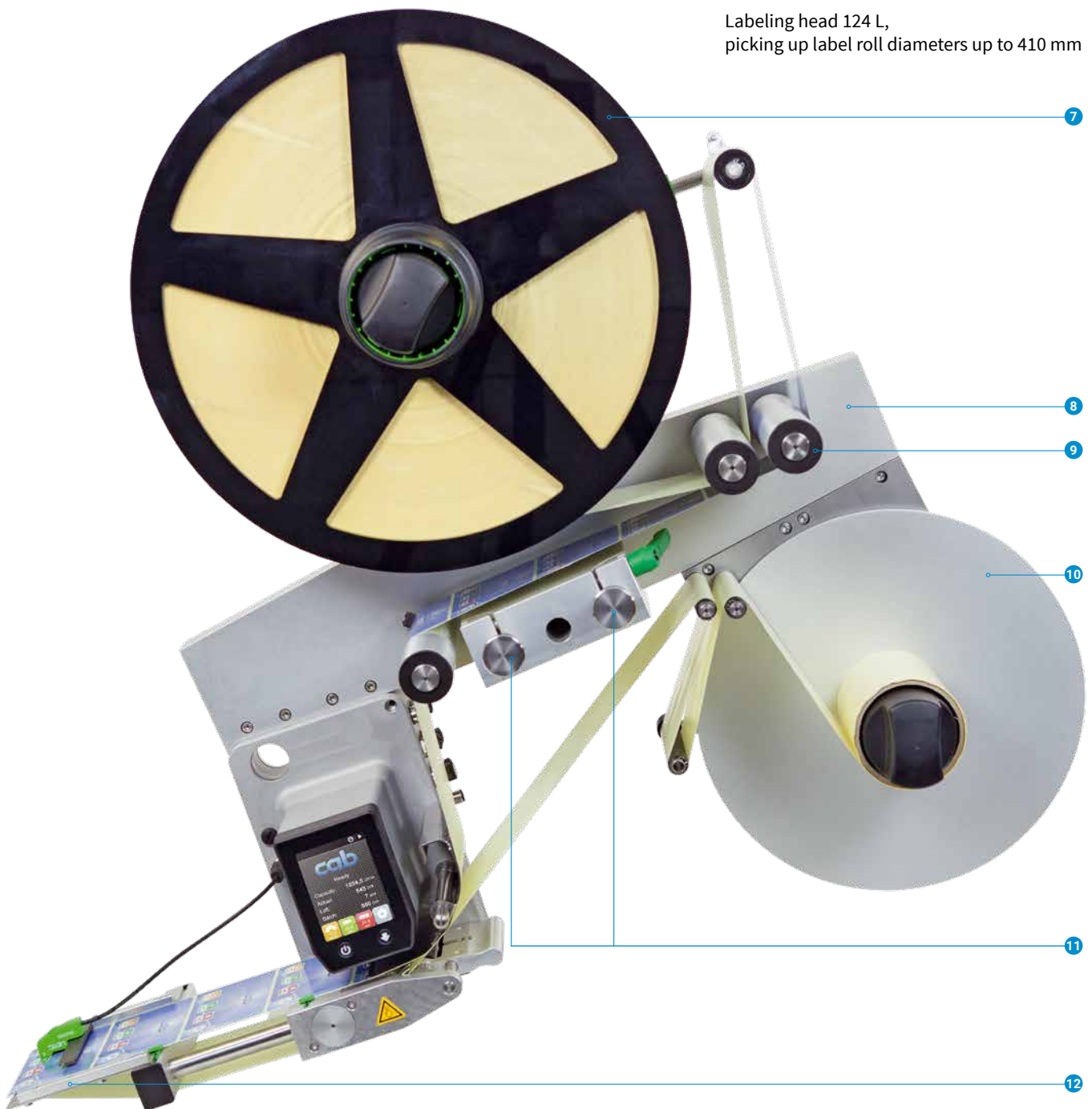

- 7 Motor-driven unwinder**
picking up label rolls with 410 mm (optionally 510 mm) maximum outside diameter. An integrated, brushless torque motor rotates the label roll and unwinds the label web according to the swing lever position.
- 8 Fixing bar**
to pick up all the units: base unit and motor-driven winders
- 9 Deflection rollers**
to guide the label web from the motor-driven unwinder to the base unit. Diameter 38 mm as pictured above

- 10 Motor-driven rewinder**
When the labels have been peeled off, the liner tape is rewound. The swing lever and an integrated, brushless torque motor enable the liner tape to be constantly tensed after passing the drive roller.
- 11 Pick-up points**
see position **6**
- 12 Peel-off plate**
to be application-specifically configured with the help of a comprehensive construction kit.

Base unit

The base unit can be considered the heart of every labeling head. Included are the drive roller for label web transport, a brushless servo motor and the control unit containing the operation panel.



Interfaces:

- 1 END/DIM Inputs**
End of label web
Pre-warning to end of label web

2 LAN

- 3 START Input**
Labeling

4 Digital I/O interface

Analog inputs

- Speed
- Start delay
- Stop delay

Digital inputs

- Labeling head ON
- Pre-dispense
- Start labeling
- Start labeling locked
- Error reset
- User-defined

Outputs

- Labeling head ready
- Pre-dispense
- Stop label feed
- Label feed running
- Label missing on liner tape
- End of label web
- Pre-warning to end of label web
- Error
- User-defined

- 5 SYNC Input**
Synchronized label and product speed

- 6 APPLY USB Inputs**
Transfer unit in initial position
Transfer unit in operating position
Printer busy

- Outputs**
Transfer unit
Label blow-off
Start printer

7 POWER

- 8 PRINT Input**
Printer busy

- Outputs**
Start printer
Start transfer unit

9 WLAN

- 10 STOP Input**
Label sensor stop signal

- Output**
Label sensor Teach signal



Technical data - labeling head

Labeling head	Structural width	124 mm (4.9")	186 mm (7.3")	248 mm (9.7")	310 mm (12.2")	
Performance						
Web speed	up to m/min	25, 50, 100, 200 - depending from device model				
	up to ipm	1,000, 2,000, 4,000, 8,000 - depending from device model				
Material						
Labels on roll		Paper, plastics PET, PE, PP, PVC				
Thickness	mm	0.055 - 1				
Weight	g/m ²	60 - 700				
Width	Labels ¹⁾	up to mm	120	182	244	306
	Liner tape	up to mm	124	186	248	310
Label length	mm	5 - 6,000				
Media roll	Outside diameter	310/410 mm (12"/16")			410 mm (16")	
	Core diameter	76 mm (3")				
	Winding	outside or inside				
Weight	up to kg	15				
Labeling head sizes and weights						
Height	with media roll 310 mm min. mm	600 x 600			-	
x Width	with media roll 410 mm min. mm	700 x 680			825 x 925	
Depth	mm	266	328	390	452	
Weight	min. kg	14	14.5	15	32	
Device data						
Drive		AC servo motor				
Operation panel		QVGA-resoluted LCD color display				
Masterencoder (option)		24 V HTL, track A + B				
Orientation of assembly		vertical / horizontal				
Label sensor						
Method		Transmitted light, inductive, capacitive ²⁾ , ultrasonic ²⁾				
Function		Detection of label margins and end of materials				
Interfaces						
Digital I/O interface		17 pin, 24 V PNP to communicate signals with a superior control unit (galvanically isolated)				
Analog		Inputs (0-10 V / 0-24 V) for speed, START , STOP parameters in conjunction with PLC supplied by the customer or potentiometer (galvanically isolated)				
LAN		MQTT, Modbus, Ethernet/IP ²⁾ , OPC UA ²⁾				
WLAN		WLAN 802.11 b/g/n, 150 MBit/s, 2.4 GHz				
Periphery (APPLY)		12 pin, to connect USB warning light and applicator (24 V PNP, galvanically isolated)				
End of web sensor		5 pin, 24 V PNP or end of web sensor by cab				
Start and stop sensor		5 pin each, 24 V PNP (galvanically isolated)				
Synchronized product speed		5 pin, 24 V PNP external synchronization signal or by masterencoder (galvanically isolated), masterencoder is an option				
Serial (option)		RS232/RS485				
Operating data						
Mains Protection class		primarily TN and TT grids Protection class I				
Power supply Power consumption		100 - 240 VAC, 50 - 60 Hz up to 4 A				
External fusing		120 V: at least 6 A slow, up to 20 A / 230 V: at least 3 A slow, up to 16 A				
Leakage current		EN 60950: 260 V / 60 Hz: 1.0 mA				
Type of protection		IEC 60529: IP 66, UL 50 type 12, NEMA 250 type 12				
Temperature / humidity	Operation	0 - 40 °C / 10 - 85 %, not condensing				
	Stock	0 - 60 °C / 20 - 80 %, not condensing				
	Transport	-25 - 60 °C / 20 - 80 %, not condensing				
Approvals		CE, FCC, IC, ICES-3, CB, cULus				
Operation panel						
LED buttons		ON, FEED				
LCD graphics display	Width x Height mm	54 x 70				
Settings		Language settings, device settings, interfaces, memory for 100 product formats				
On display		Operational and warning messages				
Monitoring / test routines						
Label web		Pre-warning to end of label web, end of label web, label web broken				
Drive		Torque, temperature, power supplies, currents				
Electrical outputs		Overload protection, short circuit, reverse polarity				
System		Diagnostics when device is switched on, I/O test menu integrated				

¹⁾The label size is further defined by the type of applicator. Limitations may apply to small labels, thin materials or strong adhesive. Such applications need to be tested.

²⁾ on request

Motor-driven winders

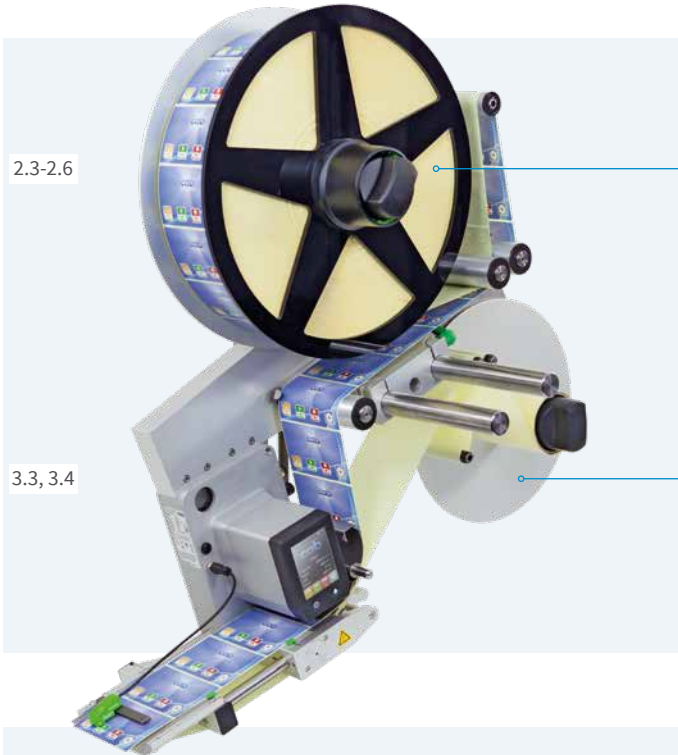

Use is in combination with the base unit.
They are operated via the operation panel of the labeling head.

- 1 **Motor-driven unwinder**
picking up the label roll and providing the label web;
fitting with large label roll diameters up to 410 / 510 mm
and high labeling performances
- 2 **Motor-driven rewinder**
picking up the liner tape;
available in diameters 310 and 410 mm;
ideally operated in conjunction with a motor-driven unwinder

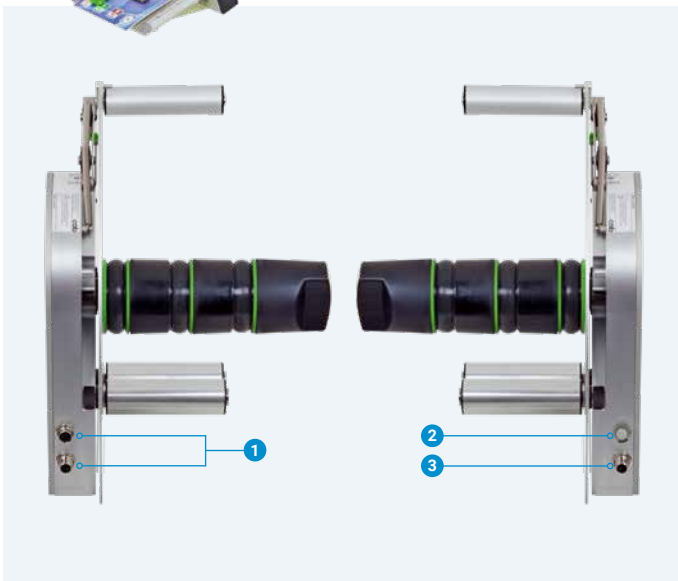

Interfaces:

- 1 **POWER**
Power supply IN/OUT
- cab BUS**
Data interface to base unit
- 2 **ON/OFF switch**
- 2 **Digital I/O interface** (option)
 - Inputs**
 - Winder ON
 - Error reset
 - User-defined
 - Outputs**
 - Winder ready
 - End of label web
 - Pre-warning to end of label web
 - Error
 - User-defined

Technical data - motor-driven winders

Winder motor-driven		Structural width	124 mm (4.9")	186 mm (7.3")	248 mm (9.7")	310 mm (12.2")
Performance						
Web speed		up to m/min	125			
		up to ipm	5,000			
Material						
Labels on roll			Paper, plastics PET, PE, PP, PVC			
Thickness		mm	0.055 - 1			
Weight		g/m ²	60 - 700			
Width	Labels	up to mm	120	182	244	306
	Liner tape	up to mm	124	186	248	310
Label length		mm	5 - 6,000			
Media roll	Outside diameter		410 / 510 mm (16"/20")			
	Core diameter		76 mm (3")			
	Winding		outside or inside			
Weight	Unwinder	up to kg	30			
	Rewinder	up to kg	15			
Winder sizes and weights						
Height	with media roll 410 mm min. mm		430 x 490			
	x Width with media roll 510 mm min. mm		530 x 590			
Depth		mm	266	328	390	452
Weight		min. kg	7			
Device data						
Drive			brushless torque motor			
Orientation of assembly			vertical / horizontal			
Interface						
Digital I/O interface (option)			12 pin, 24 V PNP to communicate signals with a superior control unit (galvanically isolated)			
Operating data						
Mains Protection class			primarily TN and TT grids Protection class I			
Power supply Power consumption			100 - 240 V~, 50 - 60 Hz up to 2 A			
POWER IN POWER OUT			up to 12 A up to 10 A			
External fusing			100 V: at least 3 A slow, up to 20 A / 230 V: at least 1.5 A slow, up to 16 A			
Leakage current			EN 60950: 260 V / 60 Hz: 0.5 mA			
Type of protection			IEC 60529: IP 66, UL 50 type 12, NEMA 250 type 12			
Temperature / humidity	Operation		0 - 40 °C / 10 - 85 %, not condensing			
	Stock		0 - 60 °C / 20 - 80 %, not condensing			
	Transport		-25 - 60 °C / 20 - 80 %, not condensing			
Approvals			CE, FCC, IC, ICES-3, CB, cULus			
Monitoring / test routines						
Label web			Pre-warning to end of label web, end of label web, label web broken			
Drive			Torque, temperature, power supplies, currents			
Electrical outputs			Overload protection, short circuit, reverse polarity			
System			Diagnostics when device is switched on			

Peel-off plates

4.1, 4.2



Peel-off plate standard

provided in lengths of 100 mm or 160 mm



pictured with a label sensor CEON and a wipe-down roller

4.4, 4.5



Peel-off plate adjustable 0° to +75°

to be continuously adjusted at angles from 0° to +75° to the corresponding application field.



pictured with a label sensor CEON and a wipe-down roller

4.6, 4.7

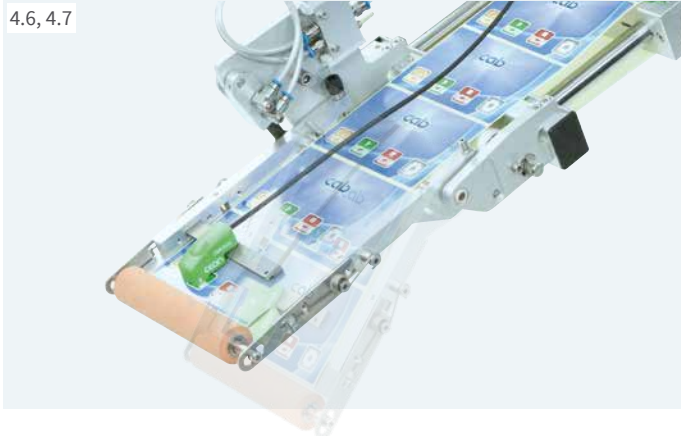

Peel-off plate pivoted 0° to -30°

swinging downwards by up to -30°. The pneumatic drive is controlled via the base unit (pictured are 124 mm). Structural widths of at least 186 mm provide drives on both sides. Uneven products can be labeled and labels be dispensed into pockets.



pictured with a label sensor CEON and a wipe-down roller

4.9

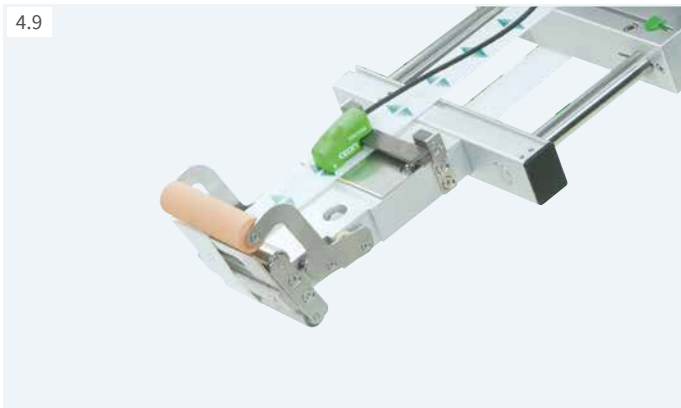

Peel-off plate 75° with a wipe-down roller

as a size-optimized unit with a fixed 75° label tape deflection angle. A spring-mounted wipe-down roller to be adjusted in rest position is included next to a retainer to fix the label sensor CEON.



pictured with a label sensor CEON

Accessories

5.1



Label sensor CEON

to detect and exactly position all conventional (even particularly thin, transparent or metallized) label materials at any mesh width:

- easy to assemble on the peel-off plate
- precise detection even at very high dispensing speeds up to 24,000 ipm
- high repeat accuracy
- comfortable AutoTeach sensor balance directly on the labeling head
- Operating voltage 15 to 30 VDC
- Push-pull amplifier output: PNP, NPN, 40mA, short-circuit proof

11.1



I/O box

to extend the programmable inputs and outputs provided with the labeling head. The signals are mainly used for customer-specific label application system control:

- 1 **Connection to labeling head**
M12, 12 pin
- 2 **Connection to further participant**
M12, 12 pin
- 3 **Digital inputs/outputs, analog inputs**
M8, 3 pin

A total of 12 inputs and outputs are available per box.

16.1



External operation panel 4.3"

providing the same functionality as on the labeling head; landscape or portrait mode display











Users are free to choose whether to operate the labeling head on the external panel or on the one integrated in the device.









- 1 **LED:** Power ON
- 2 **USB slot** to connect a memory stick in order to transfer configuration data or the firmware











A maximum of three participants can be connected to the base unit: for example 2 x I/O box, 1 x external operation panel

Accessories

Label margin detection	
5.2	 <p>Retainer bar to assemble the label sensor CEON on the peel-off plates</p>
5.3	 <p>Forked light barrier to detect translucent labels with transparent or semi-transparent liner tapes; optical operation principle (transmitted light)</p>
5.4	 <p>Retainer to assemble the forked light barrier on the assembly rods 7.1</p>
Software key	
6.1	 <p>Speed key to define the maximum labeling speed for the base units 1.1 to 1.4</p>
Assembly rod	
7.1	 <p>Rod, diameter 16 mm to assemble the peel-off plates 4.1 to 4.6 on the base units 1.1 to 1.4</p> <p>Depending from the orientation of assembly, users can choose between different lengths. Distance peel-off plate to base unit 0 to 600 mm</p>
Product detection	
8.1	 <p>Product sensor to trigger the labeling process as soon as the product has been detected. The maximum scanning range standard is 200 mm, with transparent products it is 80 mm.</p>
8.2	 <p>Product sensor cable M12-M8, 4 pin, a-coded Length 2.5 m</p>
Masterencoder	
9.1	 <p>Rotary encoder, incremental, diameter 50 mm with cable 2.5 m and plug M12, 5 pin, a-coded A and B tracked to automatically synchronize the labeling speed</p>
9.2	 <p>Extender cable for rotary encoder M12, 5 pin, a-coded Lengths 2.5 m, 5 m, 10 m</p>
9.3	 <p>Friction wheel for rotary encoder to drive the master encoder by means of friction; circumference 200 mm</p>
9.4	 <p>Retainer for rotary encoder The friction wheel is pressed onto the conveyor belt in a spring-mounted manner.</p>

Power supply cable	
10.1	 <p>Power supply cable without a Schuko plug Lengths 2.5 m, 5 m, 10 m</p>
10.2	 <p>Power supply cable with Schuko plug Length 2.5 m</p>
Signal cable	
10.3	 <p>I/O interface cable Exchange of signals between the labeling head and a superior control unit; for signal description see page 8; lengths 2.5 m, 5 m, 10 m</p> <p>With circular connectors: 1) Cable plug M12, 17 pin, male 2) Cable jack M12, 17 pin, female</p>
10.4, 10.5	 <p>Signal cable Exchange of signals between the labeling head and label transfer units; for signal description see page 8; lengths 1 m, 2.5 m</p> <p>With circular connectors: 1) Cable plug M12, 12 pin, male 2) Cable jack M12, 12 pin, female</p>
LAN cable	
10.6	 <p>Ethernet cable M12, 4 pin, d-coded to RJ45 Lengths 2.5 m, 5 m, 10 m</p>
USB cable	
10.7	 <p>Cable to connect an external operation panel M12, 12 pin to USB-B Length 5 m</p>
10.8	 <p>USB adapter to connect a memory stick to IXOR APPLY for backup and restore Cable M12, 12 pin to USB-A Length 0.2 m</p>
Power cable	
10.9	 <p>Power cable to connect winders or winders with the base unit Lengths 0.3 m, 0.8 m, 2.5 m</p>
Counterholder	
12.1	 <p>Counterholder 310 mm to be used with a diameter 310 mm unwinder in vertically oriented labeling head assembly. It prevents the label web from accidentally sliding off the media roll.</p> <p>Counterholder 410 mm to be used with a diameter 410 mm unwinder/ motor-driven unwinder in vertically oriented labeling head assembly. It prevents the label web from accidentally sliding off the media roll.</p> <p>Counterholder 510 mm to be used with a diameter 510 mm unwinder/ motor-driven unwinder in vertically oriented labeling head assembly. It prevents the label web from accidentally sliding off the media roll.</p>

Accessories

Cover plate	
13.1 	<p>Plate to cover the mechanical port on which the rewinder connects to the base unit. It is needed if no mechanical rewinder is assembled directly on the base unit.</p>
Circular connector	
14.1 	<p>Cable plug M12, 5 pin, a-coded, male It allows to configure connecting cables yourself for the following interfaces: START END/DIM PRINT STOP For signal description see page 8</p>
	<p>Cable plug M12, 12 pin, male It allows to configure connecting cables yourself for the following interface: APPLY on the side next to the labeling head For signal description see page 8</p>
14.2 	<p>Cable jack M12, 5 pin, a-coded, female It allows to configure connecting cables yourself for the following interface: SYNC For signal description see page 8</p>
	<p>Cable jack M12, 12 pin, female It allows to configure connecting cables yourself for the following interface: APPLY on the side next to the label transfer unit For signal description see page 8</p>
Signal	
15.1 	<p>Warning light In addition to the display, it indicates the status of the device. Red Group error, e. g. end of label web, label web broken Yellow Pre-warning to end of label web Green Device ready It is assembled with the help of the stand included in delivery; length of cable is 2.5 m With 17 pin M12 circular connector to connect to the digital I/O interface</p>
Wipe-down system	
17.1 	<p>Wipe-down roller, wipe-down brush to tamp labels on products in motion</p>
Assembly aid	
18.1, 18.2 	<p>Fixing bars to assemble motor-driven winders and the base unit</p>
Deflection roller	
19.1 	Deflection roller D30 AL, paper guide integrated
	Deflection roller D38 AL, paper guide integrated
	Deflection roller D60 AL, paper guide integrated
Spacer	
20.1 	<p>Spacer for motor-driven unwinders D510, rewinders D410</p>

Accessories

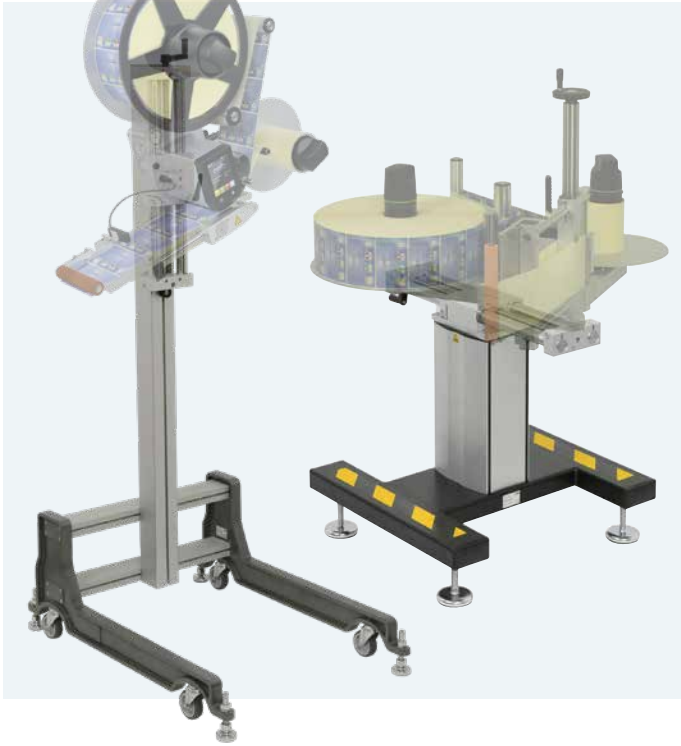

Assembly aids

to assemble the labeling head customer-specifically in production lines or integrate it in labeling machines. At this, a construction kit is provided, including

- **device retainers,**
- **column stands,**
- **floor stands.**

21.1

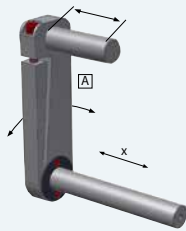

A Pivoted device retainer

to adjust the inclination of the labeling head. For example, the peel-off angle "label to product" can be set. Labeling head assembly is possible in three methods.

Method 1: Device fixed

to vertically or horizontally assemble the labeling head

The labeling head cannot be adjusted in x-axis direction.

21.2

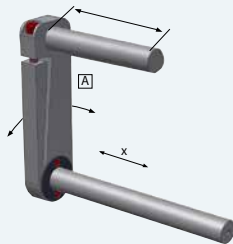

Method 2: Device moveable

to vertically assemble the labeling head

The labeling head can be adjusted in x-axis direction by 200 mm transverse the direction labels are peeled off. In case of wipe-down labeling, the label position on the product may be varied transverse the transport direction of the product.

If no **A** pivoted device retainer is assembled, the adjustable track increases by 26.5 mm.

21.3

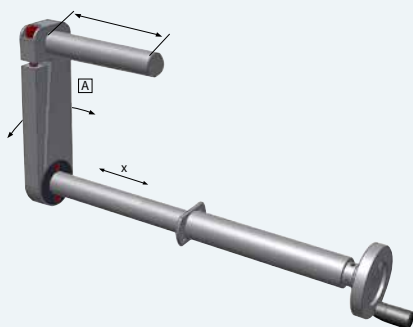

Method 3: Device precisely adjustable

to vertically or horizontally assemble the labeling head

The labeling head can be precisely adjusted by 150 mm in x-axis direction transverse the direction labels are peeled off with the help of a hand crank. In case of wipe-down labeling, the label position on the product may be varied transverse the transport direction of the product.

Accessories

22.1



Column stand, one axis

to assemble the labeling head to a conveyor belt;
position is set with the help of a hand crank

Technical data		Column stand
Column length	mm	400 - 800
Adjustable track	mm	column length in mm - 205 mm
Column diameter	mm	30

22.2

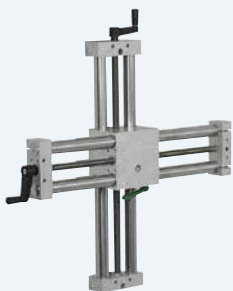

Column stand, two axes

to assemble the labeling head to a conveyor belt;
position is set with the help of a hand crank

Technical data		Column stand
Column length	mm	400 - 800
Adjustable track	mm	column length in mm - 205 mm
Column diameter	mm	30

22.3



Floor stand 1632 vertical

primarily for labeling from the top on a product. It is moveable.
On site, locking and setting is possible with the help of leveling feet.
Preferred use is with applications in various production lines

Technical data		Floor stand 1632
Leveling feet, adjustability	mm	± 15
Load	up to kg	50
Load at protrusion 300 mm	up to kg	25
Distance from lower label margin to the floor	mm	880 - 1,200
Weight	approx. kg	40

22.4



Floor stand 1231 horizontal

primarily for labeling from the side on a product. It is adjustable
in height and can be locked and set with the help of leveling feet
on site. Preferred use is with applications in various production lines

Technical data		Floor stand 1231
Leveling feet, adjustability	mm	± 15
Load	up to kg	50
Load at protrusion 200 mm	up to kg	20
Distance from lower label margin to the floor	mm	664 - 904
Weight	approx. kg	40

Overview of accessories

■ typical □ on request

Pos.	Labeling head	Structural width up to m/min	124 mm					186 mm					248 mm					310 mm		
			30	40	50	100	200	30	40	50	80	150	30	40	50	80	100	30	40	50
Winder																				
2.1	Unwinder, diameter 310 mm		■	■	■	□	-	■	■	■	□	-	■	■	□	-	-	-	-	-
2.2	Unwinder, diameter 410 mm		■	■	■	-	-	■	■	□	-	-	■	□	-	-	-	-	-	-
2.3, 2.4	Unwinder motor-driven, diameters 410, 510 mm		□	□	□	□	-	□	□	□	□	-	□	□	□	□	-	□	□	□
2.5, 2.6	Unwinder motor-driven with a double pendulum, diameters 410, 510 mm		□	□	□	□	□	□	□	□	□	□	□	□	□	□	□	□	□	□
3.1	Rewinder, diameter 210 mm		■	■	■	□	-	■	■	□	-	-	■	□	-	-	-	-	-	-
3.2	Rewinder, diameter 290 mm		■	■	□	-	-	■	□	-	-	-	□	-	-	-	-	-	-	-
3.3, 3.4	Rewinder motor-driven, diameters 310, 410 mm		□	□	□	□	□	□	□	□	□	□	□	□	□	□	□	□	□	□
4.1-4.10	Peel-off plates, rollers, installation profiles		■	■	■	■	■	■	■	■	■	■	■	■	■	■	■	□	□	□
Label margin detection																				
5.1, 5.2	Label sensor CEON, retainer bar		■	■	■	■	■	■	■	■	■	■	■	■	■	■	■	■	■	■
5.3, 5.4	Forked light barrier, retainer		■	■	■	■	□	■	■	■	■	□	■	■	■	■	■	■	■	■
Software key																				
6.1	Speed key		■	■	■	■	■	■	■	■	■	■	■	■	■	■	■	■	■	■
Assembly rod																				
7.1	Rod to assemble the peel-off plate		■	■	■	■	■	■	■	■	■	■	■	■	■	■	■	■	■	■
Product detection																				
8.1, 8.2	Product sensor, cable		■	■	■	■	■	■	■	■	■	■	■	■	■	■	■	■	■	■
Masterencoder																				
9.1-9.4	Rotary encoder, cable, friction wheel, retainer		■	■	■	■	■	■	■	■	■	■	■	■	■	■	■	■	■	■
Cable																				
10.1-10.9	Power supply cable, signal cable, LAN cable, USB cable, power cable		■	■	■	■	■	■	■	■	■	■	■	■	■	■	■	■	■	■
Interface																				
11.1	I/O box		■	■	■	■	■	■	■	■	■	■	■	■	■	■	■	■	■	■
Circular connector																				
14.1, 14.2	Cable plug M12, cable jack M12		■	■	■	■	■	■	■	■	■	■	■	■	■	■	■	■	■	■
Signal																				
15.1	Warning light		■	■	■	■	■	■	■	■	■	■	■	■	■	■	■	■	■	■
External operation panel																				
16.1	External operation panel		■	■	■	■	■	■	■	■	■	■	■	■	■	■	■	■	■	■
Wipe-down system																				
17.1	Wipe-down roller, one-sided		■	■	■	■	■	-	-	-	-	-	-	-	-	-	-	-	-	-
	Wipe-down roller, both-sided		-	-	-	-	-	■	■	■	■	■	■	■	■	■	■	□	□	□
	Wipe-down brush		■	■	■	■	■	■	■	■	■	■	■	■	■	■	■	■	■	■
Assembly aid																				
18.1, 18.2	Fixing bar		■	■	■	■	■	■	■	■	■	■	■	■	■	■	■	■	■	■
Deflection roller																				
19.1-19.3	Deflection roller		■	■	■	■	■	■	■	■	■	■	■	■	■	■	■	■	■	■
Spacer																				
20.1	Spacer for motor-driven winder		■	■	■	■	■	■	■	■	■	■	■	■	■	■	■	■	■	■
Orientation of assembly																				
		up to mm	vertical	horizontal	vertical	horizontal	vertical	horizontal	vertical	horizontal	vertical	horizontal	vertical	horizontal	vertical	horizontal				
	Rewinder diameter		210 290	310	210 290	310	210 290	310	210 290	310	210 290	310	210 290	310	310	310				
Counterholder																				
12.1	Counterholder		■	■	-	-	■	■	-	-	■	■	-	-	■	■	-	-	■	-
Cover plate																				
13.1	Cover plate		-	■	-	■	-	■	-	■	-	■	-	■	■	■	■	■	■	■
Device retainer																				
21.1	Device fixed		■	-	■	-	■	-	■	-	■	-	■	-	-	-	-	-	-	-
21.2	Device moveable		■	-	-	-	■	-	-	-	■	-	-	-	-	-	-	-	-	-
21.3	Device precisely adjustable		■	-	■	-	■	-	■	-	■	-	□	-	-	-	-	-	-	-
Device retainer - special equipment																				
21.4-21.6	Pivoted retainer, digital counter, extender		■	-	■	-	■	-	■	-	■	-	■	-	-	-	-	-	-	-
Stand																				
22.1-22.4	Column stand, floor stand		■	■	■	■	■	■	■	■	■	■	■	■	■	■	■	■	□	□
Stand - special equipment																				
22.5-22.7	Angular gear, digital counter, adjusting disc		■	■	■	■	■	■	■	■	■	■	■	■	■	■	■	■	■	■

Delivery program

Left-hand construction

Pos.	Part no.	Base units	
1.1	6121131	Base unit 124 L	
1.2	6121133	Base unit 186 L	
1.3	6121135	Base unit 248 L	
1.4	6121137	Base unit 310 L	
Pos.	Part no.	Unwinders	
2.1	5983300	Unwinder D310 H 124 L	
	5983302	Unwinder D310 H 186 L	
	5983304	Unwinder D310 H 248 L	
	6122000	Unwinder D310 VH 62 L	
	5983312	Unwinder D310 V 124 L	
	5983314	Unwinder D310 V 186 L	
2.2	5983316	Unwinder D310 V 248 L	
	5983306	Unwinder D410 H 124 L	
	5983308	Unwinder D410 H 186 L	
	5983310	Unwinder D410 H 248 L	
	6122002	Unwinder D410 VH 62 L	
	5983318	Unwinder D410 V 124 L	
2.3	5983320	Unwinder D410 V 186 L	
	5983322	Unwinder D410 V 248 L	
	Pos.	Part no.	Unwinders motor-driven
	2.3	5983501	Unwinder D410 H 124 L motor-driven
		5983502	Unwinder D410 H 186 L motor-driven
		5983503	Unwinder D410 H 248 L motor-driven
5983504		Unwinder D410 H 310 L motor-driven	
5983505		Unwinder D410 V 124 L motor-driven	
5983506		Unwinder D410 V 186 L motor-driven	
2.4	5983507	Unwinder D410 V 248 L motor-driven	
	5983508	Unwinder D410 V 310 L motor-driven	
	5983509	Unwinder D510 H 124 L motor-driven	
	5983510	Unwinder D510 H 186 L motor-driven	
	5983511	Unwinder D510 H 248 L motor-driven	
	5983512	Unwinder D510 V 124 L motor-driven	
2.5	5983513	Unwinder D510 V 186 L motor-driven	
	5983514	Unwinder D510 V 248 L motor-driven	
	Pos.	Part no.	Unwinders with a double pendulum
	2.5	5983519	Unwinder D410 H 124 L DP motor-driven
		5983520	Unwinder D410 H 186 L DP motor-driven
		5983521	Unwinder D410 H 248 L DP motor-driven
5983522		Unwinder D410 V 124 L DP motor-driven	
5983523		Unwinder D410 V 186 L DP motor-driven	
5983524		Unwinder D410 V 248 L DP motor-driven	
2.6	5983525	Unwinder D510 H 124 L DP motor-driven	
	5983526	Unwinder D510 H 186 L DP motor-driven	
	5983527	Unwinder D510 V 124 L DP motor-driven	
	5983528	Unwinder D510 V 186 L DP motor-driven	

Type code: base unit	
Labeling head	186 L
Label web width	62 mm
	124 mm
	186 mm
	248 mm
	310 mm
Label application	to the left L
	to the right R

Right-hand construction

Pos.	Part no.	Base units	
1.1	6121132	Base unit 124 R	
1.2	6121134	Base unit 186 R	
1.3	6121136	Base unit 248 R	
1.4	6121138	Base unit 310 R	
Pos.	Part no.	Unwinders	
2.1	5983301	Unwinder D310 H 124 R	
	5983303	Unwinder D310 H 186 R	
	5983305	Unwinder D310 H 248 R	
	6122001	Unwinder D310 VH 62 R	
	5983313	Unwinder D310 V 124 R	
	5983315	Unwinder D310 V 186 R	
2.2	5983317	Unwinder D310 V 248 R	
	5983307	Unwinder D410 H 124 R	
	5983309	Unwinder D410 H 186 R	
	5983311	Unwinder D410 H 248 R	
	6122003	Unwinder D410 VH 62 R	
	5983319	Unwinder D410 V 124 R	
2.3	5983321	Unwinder D410 V 186 R	
	5983323	Unwinder D410 V 248 R	
	Pos.	Part no.	Unwinders motor-driven
	2.3	5983540	Unwinder D410 H 124 R motor-driven
		5983541	Unwinder D410 H 186 R motor-driven
		5983542	Unwinder D410 H 248 R motor-driven
5983543		Unwinder D410 H 310 R motor-driven	
5983544		Unwinder D410 V 124 R motor-driven	
5983545		Unwinder D410 V 186 R motor-driven	
2.4	5983546	Unwinder D410 V 248 R motor-driven	
	5983547	Unwinder D410 V 310 R motor-driven	
	5983548	Unwinder D510 H 124 R motor-driven	
	5983549	Unwinder D510 H 186 R motor-driven	
	5983550	Unwinder D510 H 248 R motor-driven	
	5983551	Unwinder D510 V 124 R motor-driven	
2.5	5983552	Unwinder D510 V 186 R motor-driven	
	5983553	Unwinder D510 V 248 R motor-driven	
	Pos.	Part no.	Unwinders with a double pendulum
	2.5	5983558	Unwinder D410 H 124 R DP motor-driven
		5983559	Unwinder D410 H 186 R DP motor-driven
		5983560	Unwinder D410 H 248 R DP motor-driven
5983561		Unwinder D410 V 124 R DP motor-driven	
5983562		Unwinder D410 V 186 R DP motor-driven	
5983563		Unwinder D410 V 248 R DP motor-driven	
2.6	5983564	Unwinder D510 H 124 R DP motor-driven	
	5983565	Unwinder D510 H 186 R DP motor-driven	
	5983566	Unwinder D510 V 124 R DP motor-driven	
	5983567	Unwinder D510 V 186 R DP motor-driven	

Type code: winders	
Unwinder, rewinder	D410 H 124 L DP
Outside diameter	up to 210 mm
	290 mm
	310 mm
	410 mm
	510 mm
	610 mm
Orientation of assembly	vertical V
	horizontal H
Label web width	62 mm
	124 mm
	186 mm
	248 mm
	310 mm
Label application	to the left L
	to the right R
Pendulum	double

Delivery program











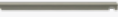
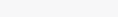





















Left-hand construction

Pos.	Part no.	Rewinders
3.1	6122030	Rewinder D210 62 L
	5977688	Rewinder D210 124 L
	5983250	Rewinder D210 186 L
	5983252	Rewinder D210 248 L
3.2	6122032	Rewinder D290 62 L
	5983254	Rewinder D290 124 L
	5983256	Rewinder D290 186 L
	5983258	Rewinder D290 248 L
Pos.	Part no.	Rewinders motor-driven
3.3	5983531	Rewinder D310 124 L motor-driven
	5983532	Rewinder D310 186 L motor-driven
	5983533	Rewinder D310 248 L motor-driven
	5983534	Rewinder D310 310 L motor-driven
3.4	5983535	Rewinder D410 124 L motor-driven
	5983536	Rewinder D410 186 L motor-driven
	5983537	Rewinder D410 248 L motor-driven
Pos.	Part no.	Peel-off plates standard
4.1	6126000	Peel-off plate 100 mm 62 L
	6126001	Peel-off plate 100 mm 124 L
	6126002	Peel-off plate 100 mm 186 L
	6126003	Peel-off plate 100 mm 248 L
4.2	6126004	Peel-off plate 100 mm 310 L
	6126010	Peel-off plate 160 mm 62 L
	6126011	Peel-off plate 160 mm 124 L
	6126012	Peel-off plate 160 mm 186 L
4.3	6126013	Peel-off plate 160 mm 248 L
	6126014	Peel-off plate 160 mm 310 L
	6127475	Roller enabling smoother web run 62 L
	6127476	Roller enabling smoother web run 124 L
4.3	6127477	Roller enabling smoother web run 186 L
	6127478	Roller enabling smoother web run 248 L
	6127479	Roller enabling smoother web run 310 L
	Pos.	Part no.
4.4	6126020	Peel-off plate 100 mm 62 L adjustable
	6126021	Peel-off plate 100 mm 124 L adjustable
	6126022	Peel-off plate 100 mm 186 L adjustable
	6126023	Peel-off plate 100 mm 248 L adjustable
4.5	6126030	Peel-off plate 160 mm 62 L adjustable
	6126031	Peel-off plate 160 mm 124 L adjustable
	6126032	Peel-off plate 160 mm 186 L adjustable
	6126033	Peel-off plate 160 mm 248 L adjustable
Pos.	Part no.	Peel-off plates pivoted 0° to -30°
4.6	6126060	Peel-off plate 100 mm 62 L pivoted
	6126061	Peel-off plate 100 mm 124 L pivoted
	6126062	Peel-off plate 100 mm 186 L pivoted
	6126063	Peel-off plate 100 mm 248 L pivoted
4.7	6126070	Peel-off plate 160 mm 62 L pivoted
	6126071	Peel-off plate 160 mm 124 L pivoted
	6126072	Peel-off plate 160 mm 186 L pivoted
	6126073	Peel-off plate 160 mm 248 L pivoted
4.8	5955735	Compressed air regulation unit L
Pos.	Part no.	Peel-off plates 75° with a wipe-down roller
4.9	6127800	Peel-off plate 75° L x W: 50 x 42 mm
	6127801	Peel-off plate 75° L x W: 50 x 62 mm
	6127802	Peel-off plate 75° L x W: 50 x 82 mm
	6127803	Peel-off plate 75° L x W: 100 x 82 mm
4.10	6120052	Installation profile for a plate 75° 124 L
	6120056	Installation profile for a plate 75° 186 L
	6120060	Installation profile for a plate 75° 248 L











Right-hand construction













Pos.	Part no.	Rewinders
3.1	6122031	Rewinder D210 62 R
	5983230	Rewinder D210 124 R
	5983251	Rewinder D210 186 R
	5983253	Rewinder D210 248 R
3.2	6122033	Rewinder D290 62 R
	5983255	Rewinder D290 124 R
	5983257	Rewinder D290 186 R
	5983259	Rewinder D290 248 R
Pos.	Part no.	Rewinders motor-driven
3.3	5983570	Rewinder D310 124 R motor-driven
	5983571	Rewinder D310 186 R motor-driven
	5983572	Rewinder D310 248 R motor-driven
	5983573	Rewinder D310 310 R motor-driven
3.4	5983574	Rewinder D410 124 R motor-driven
	5983575	Rewinder D410 186 R motor-driven
	5983576	Rewinder D410 248 R motor-driven
Pos.	Part no.	Peel-off plates standard
4.1	6126005	Peel-off plate 100 mm 62 R
	6126006	Peel-off plate 100 mm 124 R
	6126007	Peel-off plate 100 mm 186 R
	6126008	Peel-off plate 100 mm 248 R
4.2	6126009	Peel-off plate 100 mm 310 R
	6126015	Peel-off plate 160 mm 62 R
	6126016	Peel-off plate 160 mm 124 R
	6126017	Peel-off plate 160 mm 186 R
4.3	6126018	Peel-off plate 160 mm 248 R
	6126019	Peel-off plate 160 mm 310 R
	6127480	Roller enabling smoother web run 62 R
	6127481	Roller enabling smoother web run 124 R
4.3	6127482	Roller enabling smoother web run 186 R
	6127483	Roller enabling smoother web run 248 R
	6127484	Roller enabling smoother web run 310 R
	Pos.	Part no.
4.4	6126025	Peel-off plate 100 mm 62 R adjustable
	6126026	Peel-off plate 100 mm 124 R adjustable
	6126027	Peel-off plate 100 mm 186 R adjustable
	6126028	Peel-off plate 100 mm 248 R adjustable
4.5	6126035	Peel-off plate 160 mm 62 R adjustable
	6126036	Peel-off plate 160 mm 124 R adjustable
	6126037	Peel-off plate 160 mm 186 R adjustable
	6126038	Peel-off plate 160 mm 248 R adjustable
Pos.	Part no.	Peel-off plates pivoted 0° to -30°
4.6	6126065	Peel-off plate 100 mm 62 R pivoted
	6126066	Peel-off plate 100 mm 124 R pivoted
	6126067	Peel-off plate 100 mm 186 R pivoted
	6126068	Peel-off plate 100 mm 248 R pivoted
4.7	6126075	Peel-off plate 160 mm 62 R pivoted
	6126076	Peel-off plate 160 mm 124 R pivoted
	6126077	Peel-off plate 160 mm 186 R pivoted
	6126078	Peel-off plate 160 mm 248 R pivoted
4.8	5955736	Compressed air regulation unit R
Pos.	Part no.	Peel-off plates 75° with a wipe-down roller
4.9	6127800	Peel-off plate 75° L x W: 50 x 42 mm
	6127801	Peel-off plate 75° L x W: 50 x 62 mm
	6127802	Peel-off plate 75° L x W: 50 x 82 mm
	6127803	Peel-off plate 75° L x W: 100 x 82 mm
4.10	6120054	Installation profile for a plate 75° 124 R
	6120058	Installation profile for a plate 75° 186 R
	6120062	Installation profile for a plate 75° 248 R

Delivery program

Pos.	Part no.	Label margin detection
5.1	 5983588	Label sensor CEON
5.2	 6127425	Retainer bar label sensor CEON on peel-off plate Label web width 62 mm
	 6127426	Retainer bar label sensor CEON on peel-off plate Label web width 124 mm
5.3	 5918670	Forked light barrier
5.4	 5972608	Retainer to assemble forked light barrier
Pos.	Part no.	Software keys
6.1	 5581001	Speed key 12 m/min
	5581002	Speed key 25 m/min
	5581003	Speed key 50 m/min
	5581028	Speed key 75 m/min
	5581004	Speed key 100 m/min
	5581005	Speed key 150 m/min
5581006	Speed key 200 m/min	
Pos.	Part no.	Rods to assemble a peel-off plate
7.1	 5972443	Assembly rod, diameter 16 mm Distance to the device 0 mm
	 5972418	Assembly rod, diameter 16 mm Distance to the device 100 mm
	 5972703	Assembly rod, diameter 16 mm Distance to the device 150 mm
	 5972419	Assembly rod, diameter 16 mm Distance to the device 200 mm
	 5972420	Assembly rod, diameter 16 mm Distance to the device 300 mm
	 6120067	Assembly rod, diameter 16 mm Distance to the device 400 mm
	 5972421	Assembly rod, diameter 16 mm Distance to the device 600 mm
Pos.	Part no.	Product detection
8.1	 5918702	Product sensor, light switch up to 200 mm
	5918703	Product sensor, light switch with transparent products up to 80 mm
8.2	 5918671	Product sensor cable M12-M8, 4 pin, a-coded, length 2.5 m
Pos.	Part no.	Masterencoder
9.1	 5918979	Rotary encoder with cable 2.5 m
9.2	 5918475	Extender cable for rotary encoder M12, 5 pin, a-coded, length 2.5 m
	 5918942	Extender cable for rotary encoder M12, 5 pin, a-coded, length 10 m
	 5918949	Rotary extender cable M12, 5 pin, a-coded, length 5 m
9.3	 5918981	Friction wheel for rotary encoder
9.4	 5918980	Retainer for rotary encoder
Pos.	Part no.	Power supply cables
10.1	 5918758	Power supply cable without Schuko plug Length 2.5 m
	5918947	Power supply cable without Schuko plug Length 5 m
	5918943	Power supply cable without Schuko plug Length 10 m
10.2	 5918531	Power supply cable with Schuko plug Length 2.5 m
Pos.	Part no.	Signal cables
10.3	 5918421	I/O interface extender cable M12, 17 pin, length 2.5 m
	5918941	I/O interface extender cable M12, 17 pin, length 10 m
	 5918948	I/O interface cable M12, 17 pin, length 5 m
10.4	 5918940	Signal cable applicator, I/O box, winder I/O M12, 12 pin, length 1 m
10.5	 5918477	Signal cable applicator, I/O box, winder I/O M12, 12 pin, length 2.5 m
Pos.	Part no.	LAN cables
10.6	 5918665	Ethernet cable M12, 4 pin d-coded to RJ45, length 2.5 m
	5918946	Ethernet cable M12, 4 pin d-coded to RJ45, length 5 m
	5918945	Ethernet cable M12, 4 pin d-coded to RJ45, length 10 m
Pos.	Part no.	USB cables
10.7	 5918955	Cable to connect an external operation panel, M12, 12 pin to USB-B, length 5 m
10.8	 5918936	USB adapter to connect a memory stick, cable M12, 12 pin to USB-A, length 0.2 m
Pos.	Part no.	Power cables to connect winders or winders with the base unit
10.9	 5918944	Power cable, length 0.3 m
	5918879	Power cable, length 0.8 m
	5918426	Power cable, length 2.5 m
Pos.	Part no.	Interfaces
11.1	 6121010	I/O box M12, 12 pin and 12 x M8, 3 pin to connect base unit
	 6121030	Module IXOR-Powerbus to connect motor-driven winders
Pos.	Part no.	Counterholders
12.1	 5983324	Counterholder 310 mm
	5983325	Counterholder 410 mm
	5983586	Counterholder 510 mm
Pos.	Part no.	Cover plate
13.1	 5983429	Cover plate

Delivery program

Pos.	Part no.	Circular connectors
14.1	 5918479	Cable plug M12, 5 pin, a-coded, male
	5918483	Cable plug M12, 12 pin, male
14.2	 5918480	Cable jack M12, 5 pin, a-coded, female
	5918484	Cable jack M12, 12 pin, female
Pos.	Part no.	Signal
15.1	 5971223	Warning light with cable length 2.5 m M12, 17 pin
Pos.	Part no.	External operation panel
16.1	 6121020	External operation panel 4.3"
Pos.	Part no.	Wipe-down systems
17.1		Wipe-down rollers for peel-off plates standard, adjustable and pivoted
		6126150 Wipe-down roller 62
		6126151 Wipe-down roller 124
		6126152 Wipe-down roller 186
		6126153 Wipe-down roller 248
		Wipe-down brushes for peel-off plates standard, adjustable and pivoted
		6126160 Wipe-down brush 62
		6126161 Wipe-down brush 124
		6126162 Wipe-down brush 186
		6126163 Wipe-down brush 248
6126164 Wipe-down brush 310		
Pos.	Part no.	Assembly aids
18.1	 6120016	Fixing bar compact to pick up motor-driven winders and base unit
18.2	 6120015	Fixing bar universal to pick up motor-driven winders and base unit
Pos.	Part no.	Deflection rollers
19.1		6127290 Deflection roller 62 D30 AL
		6127291 Deflection roller 124 D30 AL
		6127292 Deflection roller 186 D30 AL
		6127293 Deflection roller 248 D30 AL
		6127294 Deflection roller 310 D30 AL
		6127295 Deflection roller 62 D38 AL
		6127296 Deflection roller 124 D38 AL
		6127297 Deflection roller 186 D38 AL
		6127298 Deflection roller 248 D38 AL
		6127299 Deflection roller 310 D38 AL
		6127311 Deflection roller 62 D60 AL
		6127312 Deflection roller 124 D60 AL
		6127313 Deflection roller 186 D60 AL
		6127314 Deflection roller 248 D60 AL
		6127315 Deflection roller 310 D60 AL
Pos.	Part no.	Spacer
20.1	 6120018	Spacer for motor-driven winder

Pos.	Part no.	Device retainers
21.1		5983401 Device 124 fixed
		5983402 Device 186 fixed
		5983403 Device 248 fixed
		5983404 Device 310 fixed
		5983405 Device 124 fixed, pivoted
		5983406 Device 186 fixed, pivoted
		5983407 Device 248 fixed, pivoted
		5983408 Device 310 fixed, pivoted
		5983409 Device 124 moveable
		5983410 Device 186 moveable
21.2		5983411 Device 248 moveable
		5983412 Device 310 moveable
		5983413 Device 124 precisely adjustable
21.3		5983414 Device 186 precisely adjustable
		5983415 Device 248 precisely adjustable
		5983416 Device 310 precisely adjustable
Pos.	Part no.	Device retainers - special equipment
21.4	 5971614	Pivoted retainer
21.5		5983431 Digital counter, vertical axis
		5983432 Digital counter, horizontal axis
21.6	 5983428	Digital counter extender (for device retainers and stands)
Pos.	Part no.	Stands
22.1		5983420 Column stand diameter 30 mm, one axis, height 400 mm
		5983421 Column stand diameter 30 mm, one axis, height 600 mm
		5983422 Column stand diameter 30 mm, one axis, height 800 mm
22.2		5983423 Column stand diameter 30 mm, two axes, height 600 mm, width 400 mm
		5983424 Column stand diameter 30 mm, two axes, height 600 mm, width 600 mm
22.3	 5983425	Floor stand 1632 vertical column stand included diameter 30 mm, height 800 mm
22.4	 5983426	Floor stand 1231 horizontal column stand included diameter 30 mm, height 600 mm
Pos.	Part no.	Stands - special equipment
22.5	 5983427	Angular gear
22.6		5983417 Digital counter, vertical axis
		5983418 Digital counter, horizontal axis
22.7	 5972532	Adjusting disc

cab product overview

Label printers
MACH1, MACH2



Label printers
EOS 2



Label printers
EOS 5



Label printers
MACH 4S



Label printers
SQUIX 2



Label printers
SQUIX 4



Label printers
SQUIX 6.3



Label printer
A8+



Label printer
XD4T double-sided



Label printers
XC two-colored



Print and apply systems
HERMES Q



Print and apply systems
Hermes C two-colored

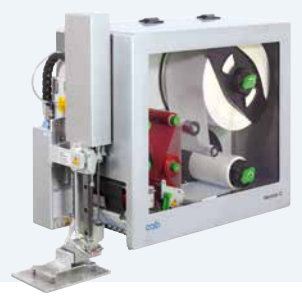

Tube labeling systems
AXON



Print modules
PX Q



Labels and ribbons



Label software
cablabel S3



Label dispensers
HS, VS



Labeling heads
IXOR



Marking lasers
XENO 4



Laser marking systems



Germany
cab Produkttechnik GmbH & Co KG
Karlsruhe
Phone +49 721 6626 0
www.cab.de

France
cab Technologies S.à.r.l.
Niedermodern
Phone +33 388 722501
www.cab.de/fr

USA
cab Technology, Inc.
Chelmsford, MA
Phone +1 978 250 8321
www.cab.de/us

Mexico
cab Technology, Inc.
Juárez
Phone +52 656 682 4301
www.cab.de/es

Taiwan
cab Technology Co., Ltd.
Taipei
Phone +886 (02) 8227 3966
www.cab.de/tw

China
cab (Shanghai) Trading Co., Ltd.
Shanghai
Phone +86 (021) 6236 3161
www.cab.de/cn

Singapore
cab Singapore Pte. Ltd.
Singapore
Phone +65 6931 9099
www.cab.de/en

South Africa
cab Technology (Pty) Ltd.
Randburg
Phone +27 11 886 3580
www.cab.de/za

cab // 820 distribution partners in more than **80** countries

cab
we identify more